

Using the jogger case

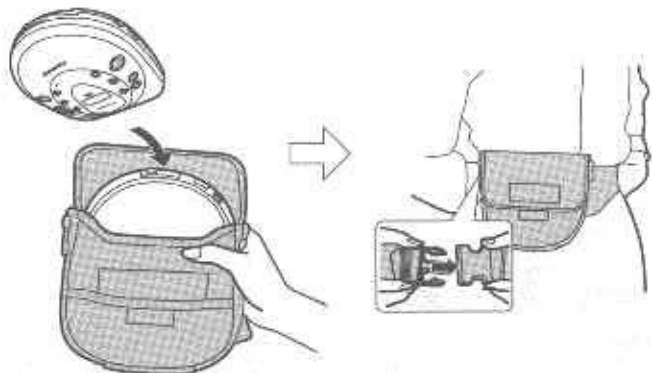

- ① Be sure the CD player is placed in the pouch so that the buttons are facing away from your body.
- ② Fasten the neoprene sport belt securely around your waist so that the unit fits snugly against your body.
- ③ Before jogging with this unit, allow sufficient time for the memory buffer to fill up completely (ideally 48 seconds).
- ④ This unit is designed for light jogging, but not for serious running. It may occasionally skip if you are an aggressive runner, or have a heavy, jarring stride.

Note

- Do not machine wash. Fading and loss of shape can occur.
- Do not expose the pouch to high temperatures when a player and CDs are inside. The player and CDs can be damaged and it can lead to fire. Be especially careful not to leave the pouch near heaters, in a car, or in the sun.
- Do not drop or hit the pouch while a player and CDs are inside. This can seriously damage the player and CDs.
- Discontinue use if a rash or skin irritation develops.
- Take special care when listening around traffic.

Portable CD player

Panasonic

Dear Customer

Thank you for purchasing this product. For optimum performance and safety, please read these instructions carefully.

Operating Instructions

Model No. **SL-SV603J**



COMPACT
disc
DIGITAL AUDIO

The model number and serial number of this product can be found on either the back or the bottom of the unit.

Please note them in the space provided below and keep for future reference.
MODEL NUMBER **SL-SV603J**
SERIAL NUMBER _____

Supplied Accessories

Check the packing carton for these accessories.

Stereo headphones	1	Wired remote control	1
(L0BAD0000159)		(N2QCBD000011)	
Jogger case	1		
		(RFC0060-K)	

Use numbers indicated in parentheses when asking for replacement parts.

To order accessories contact 1-800-332-5368 or web site (<http://www.panasonic.com>).

Before connecting, operating or adjusting this product, please read these instructions completely. Please keep this manual for future reference.

P

Panasonic Consumer Electronics Company,
Division of Matsushita Electric Corporation of America

One Panasonic Way Secaucus, New Jersey 07094 <http://www.panasonic.com>
Panasonic Sales Company, Division of Matsushita Electric of Puerto Rico, Inc. ("PSC")
Ave. 65 de Infantería, Km. 9.5 San Gabriel Industrial Park, Carolina, Puerto Rico 00985
© 2002 Matsushita Electric Industrial Co., Ltd.

En

RQT6525-P
F0202YH0
Printed in Japan

IMPORTANT SAFETY INSTRUCTIONS

Read these operating instructions carefully before using the unit. Follow the safety instructions on the unit and the safety precautions listed below. Keep these operating instructions handy for future reference.

Safety

- 1. Power source**—Connect the unit to a power source of the type described in these instructions or as marked on the unit.
- 2. Polarization**—The unit is equipped with a polarized power plug where one blade is wider than the other. This safety feature ensures that the plug fits into your household AC outlet only one way. If the plug doesn't fit one way, try reversing it. If the plug still doesn't fit, contact an electrician to replace the obsolete outlet. Do not attempt to defeat the safety purpose of the plug.
- 3. Power cord protection**—Route the AC power supply cord so that it will not be walked on or pinched by items placed on or against it. Never take hold of the plug or cord with wet hands. Always grasp the plug body firmly when connecting and disconnecting it.
- 4. Overloading**—When connecting the AC power supply cord, be careful not to overload the household AC outlet, extension cord, or outlet from any other device as this can result in fire or electric shock.
- 5. Nonuse periods**—Turn the unit off when it is not in use. Unplug the unit from the household AC outlet if it is not to be used for a long time. Unplug the unit during lightning storms. Leaving the unit connected to a household AC outlet for extended periods can cause battery fluid leakage.
- 6. Attachments and accessories**—Use only the attachments and accessories recommended in these operating instructions.

Installation

Placement

- 1. Foreign material**—Ensure objects and liquids do not get into the unit. Avoid exposing the unit to excessive smoke, dust, mechanical vibration, and shock.
- 2. Magnetism**—Situate the unit away from equipment and devices that generate strong magnetic fields.
- 3. Stacking**—Do not place anything on top of this unit.
- 4. Wall and ceiling mounting**—Do not mount the unit on walls or ceilings unless specified in the instructions.

Environment

- 1. Water and moisture**—Do not use the unit near water, such as near a bathtub or swimming pool. Avoid damp basements.
- 2. Heat**—Situate the unit away from heat sources, such as radiators. Do not leave it in an automobile exposed to direct sunlight with the doors and windows closed as this may deform the cabinet. Do not situate where temperatures fall below 5 °C (41 °F) or rise above 35 °C (95 °F).

Maintenance

(See page 5 for details.)
Unplug the unit from the household AC outlet before cleaning.
Clean with a damp cloth.
Do not use abrasive pads, scouring powders, or solvents.

Service

- 1. Damage requiring service**—The unit should be serviced by qualified service personnel if:
(a) The AC power supply cord or AC adaptor has been damaged; or
(b) Objects or liquids have gotten into the unit; or
(c) The unit has been exposed to rain; or
(d) The unit does not operate normally or exhibits a marked change in performance; or
(e) The unit has been dropped or the cabinet damaged.
- 2. Servicing**—Do not attempt to service the unit beyond that described in these operating instructions. Refer all other servicing to authorized servicing personnel.
- 3. Replacement parts**—When parts need replacing ensure the servicer uses parts specified by the manufacturer or parts that have the same characteristics as the original parts. Unauthorized substitutes may result in fire, electric shock, or other hazards.
- 4. Safety check**—After repairs or service, ask the servicer to perform safety checks to confirm that the unit is in proper working condition.



This manual was printed with soy based ink.

Power Supply Preparations

Refer to the specifications (page 8) for information on operating times when using dry cell batteries.

Important note about the memory and the power supply

To preserve the contents of the memory, ensure the unit has a constant supply of power.

- Turn the unit off before changing the batteries and before connecting or disconnecting the AC adaptor.
- The unit can maintain the memory without power for about one minute. Change batteries or reconnect the AC adaptor within this time.
- As a precaution, insert batteries even when using the AC adaptor or car adaptor.

Using the AC adaptor (not included)

Use only the recommended AC adaptor. Use of other AC adaptors can damage the unit.

To order the optional AC adaptor RP-AC46 contact 1-800-332-5368 or web site (<http://www.panasonic.com>).

Connect the AC adaptor.

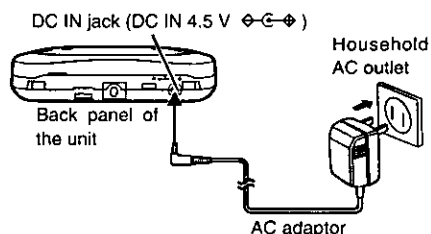

Conserving power

To save power when the unit is not to be used for a long time, unplug the AC adaptor from the household AC outlet.

Using dry cell batteries (not included)

Insert two "LR6, AA, UM-3" alkaline batteries.

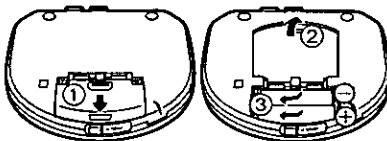

If the battery lid comes loose
Slide the lid back into place horizontally.

Removing batteries
Push up on the battery in the direction indicated by the arrow. Then lift it out.

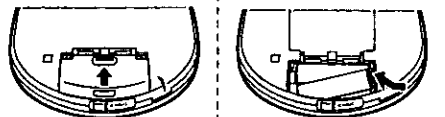

Note

The dry cell batteries should be changed when the unit is off.

Using rechargeable batteries (not included)

- If rechargeable batteries are to be used, rechargeable batteries manufactured by Panasonic are recommended.
- This unit cannot recharge batteries. The battery indicator will not function correctly when using rechargeable batteries.

Battery indicator

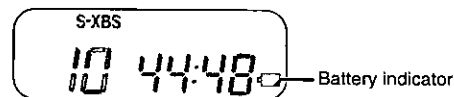

This indicator flashes when the batteries are almost out of power. Power is cut off a short while later. Replace batteries with new ones.

Note

How long the unit continues to operate after the battery indicator starts flashing depends on the type of batteries and on whether you are using the unit to play CDs or the radio.

Using the car adaptor (not included)

Use only the recommended car adaptor. Use of other car adaptors can damage the unit. Be sure to obtain the car adaptor (SH-CDC9) available as an optional accessory.

CAUTION:

Use only car adaptor, Model: SH-CDC9 manufactured by Matsushita Electric Industrial Co., Ltd.

If the unit malfunctions or freezes during use, disconnect the power source (the AC adaptor or batteries).

Re-connect the power source and continue operation.

HOLD Function

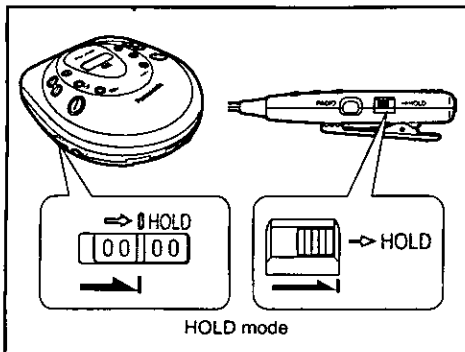

This function causes the unit to ignore accidental button presses. (The disc lid can still be opened and closed.)

HOLD function prevents the following:

- The unit is powered on accidentally when not in use, causing the batteries to run down.
- A button is accidentally pressed during play, interrupting the operation.

To use the HOLD function

Set [HOLD] to the HOLD position.

You still can operate the unit with the remote control when the main unit's HOLD function is on and vice versa.

"hold" Indication

When the main unit is in HOLD mode, pressing any button causes the indication "hold" to appear on the display.

When the unit is off

The "hold" indication appears only when [▶/||] or [RADIO/BAND] is pressed.

Before operating the buttons

Be sure to move [HOLD] to release the unit from the HOLD mode.

Location of Controls

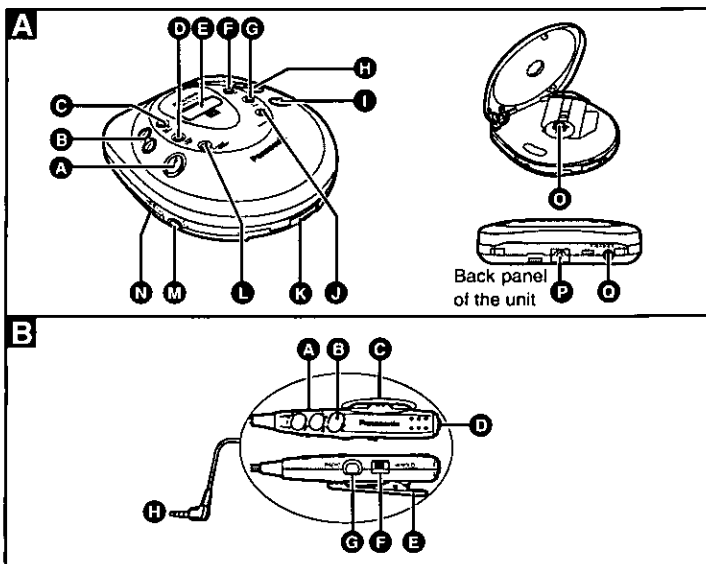

Main unit A

- A Stop/operation off button (■, OPR OFF)
- B Tuning/skip/search buttons (▶▶/+, ◀◀/-)
- C Memory/recall button (MEMORY/RECALL)
- D Tuning mode select button (TUNING MODE)
- E Display
- F S-XBS button (S-XBS)
- G Tuner on/band select button (RADIO/BAND)
- H Headphone volume control buttons (VOL+, VOL-)
- I Play/pause button (▶/||)
- J Sensitivity control, play mode button (FM RECEPT = CITY/NOR, MODE)
- K Open switch (OPEN▶)
- L Monaural/stereo button (FM MODE MONO/ST)

- M Headphone jack (🔊)
- N Hold switch (HOLD)
- O CD release button (PUSH)
- P Hole for car mounting base
- Q DC IN jack (DC IN 4.5 V ⚡)

Wired remote control B

- A Skip/search buttons (◀◀, ▶▶)
- B Play/stop/operation off button (■/▶)
- C Volume control buttons (-, VOL, +)
- D Headphone jack
- E Clip
- F Hold switch (HOLD)
- G Tuner on/off/band select button (RADIO)
- H Plug

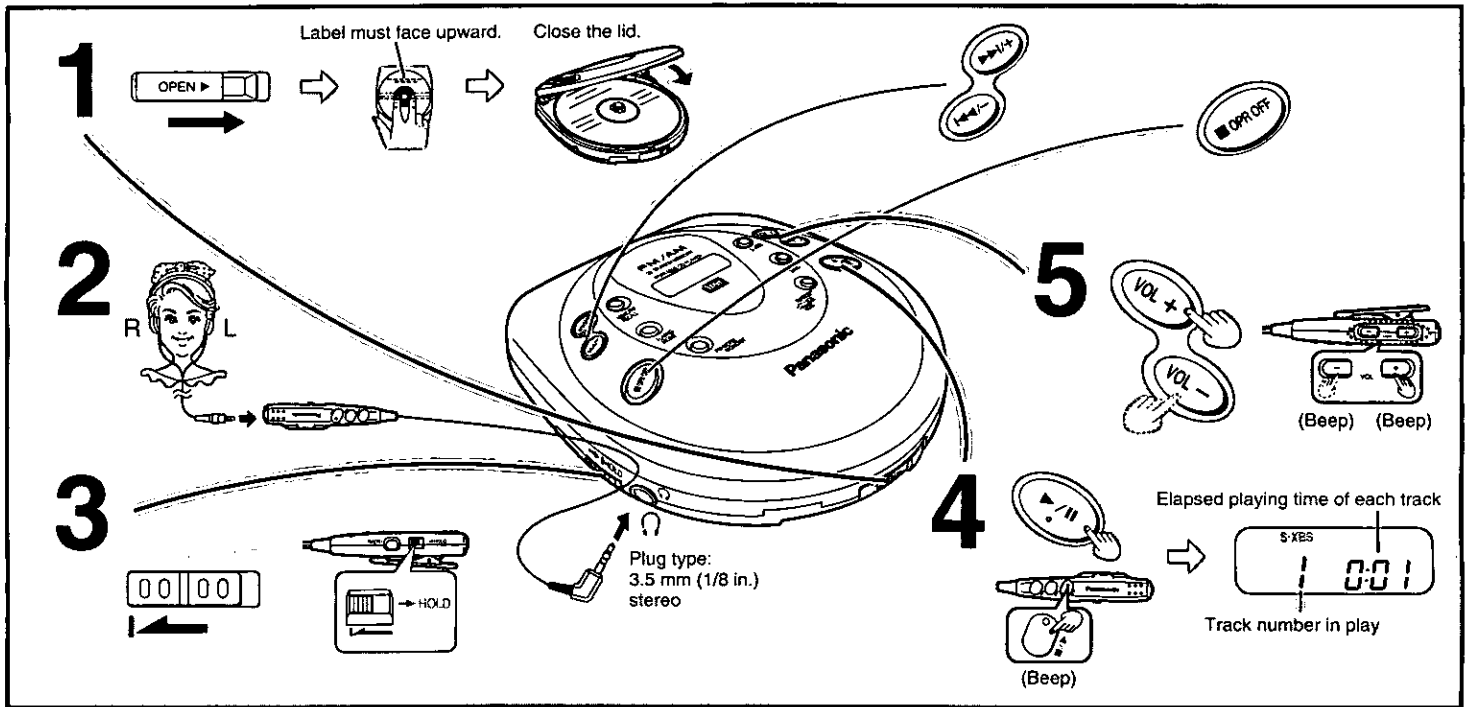

- 1** Slide [OPEN▶] to open the lid, and insert the disc.
- 2** Connect the wired remote control and the stereo headphones to [Ω]. (Plug in firmly.)
- 3** Release [HOLD].
- 4** Press [▶/||] (main unit) or press [■/▶] (remote control) to start play. (Play stops automatically when all the tracks have been played.)
- 5** Adjust the volume.
 - + : To increase the volume level
 - : To decrease the volume level
 - The volume range is 0-25. (Press and hold to change the volume successively.)
 - A tone (beep-beep) sounds when you reach the minimum or maximum volume when using the remote control.
 - The volume changes when pressed while the level is displayed. If any other display is shown, it changes to show the current level. (The volume returns to 10 when you disconnect the power source.)

- **To pause play** (main unit only)
Press during play. (Press again to restart play.)

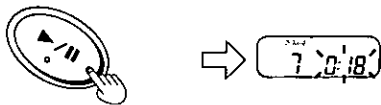

- **To stop play** Stop mode
Press during play.

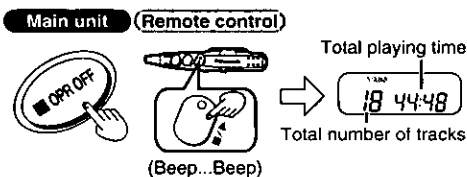

Resume function

Play starts from the beginning of the current track the next time you press [▶/||] (main unit) or [■/▶] (remote control).

Resume function notes

- Opening the lid while in the stop mode or replacing the disc while in the off mode cancels the function. (It may remain active if you replace a disc in the off mode.)
- Play may resume from the beginning of the next track if you stopped play near the end of a track.
- The resume function is automatic and you cannot turn it off.

■ To turn off the unit Off mode

Press during stop mode (main unit) or press and hold during play or stop mode (remote control).

Main unit Remote control

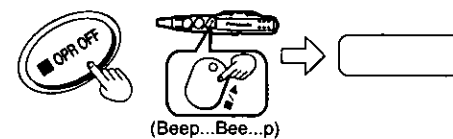

■ Skip / Search function

Skip : Press during play. (Press [◀◀/—] (main unit) or [◀◀] (remote control) twice to skip to the beginning of the previous tracks.)

Search : Press and hold during play.

Main unit Remote control

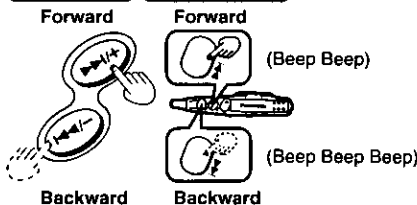

- During program play (page 4), these buttons are used to skip forward or backward through the programmed sequence of tracks.
- You cannot skip to tracks that have been played in random or random repeat play (page 4).
- During program play, 1-track repeat play, random play and random repeat play (page 4), search operation is limited to the current track only.

For your reference:

“no disc” indication

This indication appears for about 30 seconds if [▶/||] (main unit) or [■/▶] (remote control) is pressed when no disc is loaded in the unit or if the disc is not properly secured.

“OPRN” indication

This indication appears for about 10 minutes when the lid is opened. (However, the indication does not appear when the unit is turned off.)

Removing discs

- 1** Press [■, OPR OFF] to stop play and disc rotation.
 - 2** Slide [OPEN▶] to open the lid.
 - 3** Press [PUSH] to release the disc.
- Do not stop the disc by hand or try to remove it before it stops rotating. This can damage CDs.

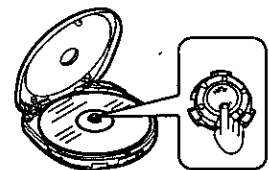

Note

Never insert foreign objects into the unit.

Auto-off function

If you leave the unit in stop mode for about 10 minutes (30 seconds if disc is not loaded), it turns off to save the batteries.

Note on CD-R and CD-RW

This unit can play CD-DA format audio CD-R and CD-RW that have been finalized* upon completion of recording. It may not be able to play some CD-R or CD-RW due to the condition of the recording.

*Finalizing is a process that enables CD-R/CD-RW players to play audio CD-R and CD-RW.

Operation confirmation tones

This tone sounds when a button on the remote control is pressed. Refer to the parentheses in the illustration for the different types of confirmation tones.

The letters such as **E** in the various illustrations refer to the descriptions in the "Location of Controls" section. (See page 2.)

Skip play

The disc plays from the specified track through to the end, then play stops automatically.

Preparation: Put unit in stop mode.

1 Select the desired track.



2



Remote control

1 Select the desired track.

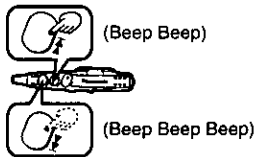

2

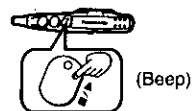

Changing the sound quality

Press during play or stop mode.



Each time the button is pressed; "S-XBS" → " " (Cancel)

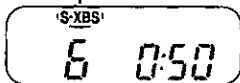

S-XBS:
Select this setting to boost the low frequency range response.

Note
The setting returns to S-XBS when you disconnect the power source.

Program play

Up to 24 tracks can be entered in the programmed sequence.

Preparation: Put unit in stop mode.

1 Select the desired track.



2 Register in sequence.

(The indication "M" and the programmed sequence appear on the display.)



3 Repeat steps 1 and 2 to program all the desired tracks.

4



■ **To program the same track in the sequence more than once**

After step 2, press [MEMORY/RECALL] the desired number of times.

■ **If "f" is displayed**
No more tracks can be programmed.

■ **To confirm the contents of the program**
Press [MEMORY/RECALL] while the disc is playing. (The numbers of the programmed tracks appear on the display in sequence.)

■ **To delete the entire programmed sequence**
Press [M, OPR OFF].

Note
The repeat and random play modes are canceled after steps 1 and 2.

Repeat play/Random play

Press during play or stop mode.

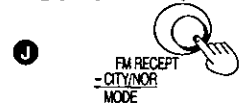

Each time the button is pressed;

"1" → " " → "RANDOM" → "RANDOM" → " " (Cancel)

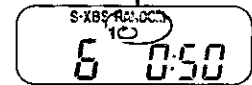

1 (1-track repeat)

One track is repeated.

(All-track repeat)

All the tracks on the disc are repeated.

RANDOM (Random)

The tracks play once each in random order and then play stops.

RANDOM (Random repeat)

The tracks play repeatedly in random order.

When pressed during program play

Each time the button is pressed;

"1 M" → " M" → "M" (Cancel)

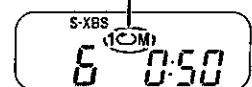

1 M (1-track repeat)

One track is repeated.

M (Memory repeat)

The programmed tracks are repeated.

Note

- You can select the first track to play in random play and random repeat play by pressing [▶|+] (main unit) or [▶|+] (remote control) while the disc is stopped. All the tracks are played.
- You cannot select random play or random repeat play during program play.
- The resume function does not work when random or random repeat are on.
- The mode is canceled when you disconnect the power source.

Anti-Skip System

This system deals with skipping in a variety of ways:

- An anti-skip mechanism prevents skipping caused when play speed changes due to swinging of the unit.
- A recovery system immediately returns the laser pick-up to its original position if it is knocked off the track by a strong shock.
- An anti-skip memory (max. 48 seconds) fills in interruptions caused by bumps and vibrations.

The anti-skip system works automatically while the unit is on and cannot be canceled.

When bumps continue repeatedly

The message "SORRY" appears on the display and sound is interrupted.

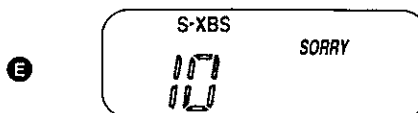

Note

- While the system is on, the disc rotates at a higher rate than usual in collecting extra audio data. This could result in a slight increase in disc rotation noise.
- The anti-skip memory compresses digital signals.

Using the Unit with Optional Accessories

Using the unit with a car audio system

Use only the specified car stereo cassette adaptor and car adaptor. The part numbers are indicated in parentheses.

Items to be purchased

For connection to the car audio system
Car stereo cassette adaptor (SH-CDM10A)

Connect the car stereo cassette adaptor to the headphone jack of the remote control and connect it to the unit's headphone jack. Set this unit's volume to 10.

For securing the unit and connecting the power supply

- Car adaptor (SH-CDC9)
- Car mounting kit (SH-CDF20)

Note when using the car mounting kit (SH-CDF20)

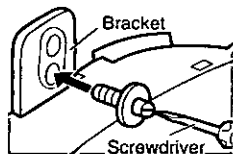

- ① Remove the screw from the bracket at the rear of the car mounting base.
- ② Replace the screw in the lower hole of the bracket.

Note

- Insert batteries even when using the car adaptor to ensure a constant power supply for the unit's memory.
- When you switch off the car, volume and sound quality may return to the original settings and the resume function may work even if you change the disc.
- It may not be possible to use the unit with some types of car stereos owing to restrictions imposed by the construction of the car stereo cassette adaptor.
- Move the unit away from the car adaptor if noise interferes with the radio.

For further details, refer to the instructions of the part concerned.

Using the unit with an audio system

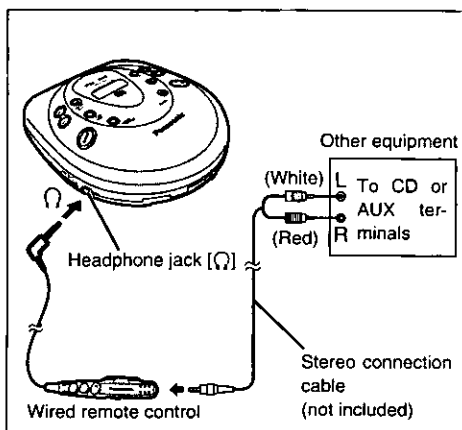

Using the stereo connection cable (not included), you can listen to CDs on your audio system. Turn off this unit and the other equipment before operation.

1 Connect the remote control to [] on the unit.

2 Connect the stereo connection cable to the remote control and the other equipment.

- The unit may malfunction if you connect directly to [] on the unit.
- Do not connect the cable to the PHONO jacks on the amplifier.

3 Set the volume to 10.

Make further volume adjustments with the other equipment.

4 Control play with the buttons on the main unit.

The tone will be heard if you use the buttons on the remote control.

Note

- Obtain the optional connecting cable if the other equipment comes with mini-phone jacks.
- If you connect speakers (active or otherwise) directly to [] on the unit, ensure they have an impedance of 1 kΩ or less.

Maintaining the Lens

Open the lid and clean the lens as shown in the figure. Use a cotton swab to gently wipe off any finger-prints. Recommended product: Lens cleaner kit (SZZP1038C)

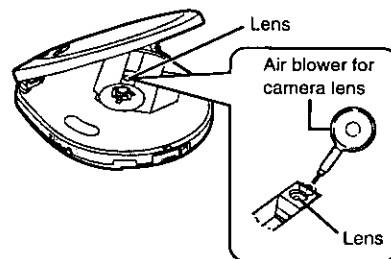

Panasonic Consumer Electronics Company,
Division of Matsushita Electric Corporation of America
One Panasonic Way Secaucus, New Jersey 07094

Panasonic Sales Company,
Division of Matsushita Electric of Puerto Rico, Inc.
Ave. 65 de Infantería, Km. 9.5
San Gabriel Industrial Park, Carolina, Puerto Rico 00985

Panasonic Portable Audio Limited Warranty

Panasonic Consumer Electronics Company or Panasonic Sales Company (collectively referred to as "the Warrantor") will repair or replace this product with new or refurbished parts or equivalent product, free of charge in the U.S.A. or Puerto Rico, in the event of a defect in materials or workmanship as follows (all time periods commence from the date of original purchase):

PARTS & LABOR - ONE (1) YEAR

Non-rechargeable batteries are not warranted

Rechargeable batteries - (when applicable) exchange defective item for new one for ten (10) days.

For assistance in the continental U.S.A. in obtaining repairs please ship the product to:

Panasonic Services Company - Customer Servicer
Suite B 4900 George McVay Drive
McAllen, TX 78503

In Puerto Rico contact the Panasonic Sales Company.

Tel. (787) 750-4300 Fax. (787) 768-2910

When shipping the unit carefully pack and send it prepaid, adequately insured and preferably in the original carton. Include a letter detailing the complaint and provide a day time phone number where you can be reached.

IF REPAIR IS NEEDED DURING THE WARRANTY PERIOD THE PURCHASER WILL BE REQUIRED TO FURNISH A SALES RECEIPT/PROOF OF PURCHASE INDICATING DATE OF PURCHASE, AMOUNT PAID AND PLACE OF PURCHASE. CUSTOMER WILL BE CHARGED FOR THE REPAIR OF ANY UNIT RECEIVED WITHOUT SUCH PROOF OF PURCHASE.

Also, the purchaser will be responsible for shipping the unit to the above address.

If you have a problem with this product that is not handled to your satisfaction, then write to the Consumer Affairs Department at the Company address indicated above.

This warranty is extended only to the original purchaser.

This warranty only covers failures due to defects in materials and workmanship which occur during normal use. The warranty does not cover damage which occurs in shipment, or failures which are caused by products not supplied by the warrantor, or failures which result from accident, misuse, abuse, neglect, mishandling, faulty installation, misapplication, improper insertion of consumables, set-up adjustments, maladjustment of consumer controls, improper operation or maintenance, improper antenna, inadequate signal reception or pickup, alteration, modification, power line surge, improper voltage supply, lightning damage, commercial use or service by anyone other than a **PANASONIC SERVICES COMPANY** authorized repair facility, or damage that is attributable to acts of God.

LIMITS AND EXCLUSIONS

There are no express warranties except as listed above.

THE WARRANTOR SHALL NOT BE LIABLE FOR INCIDENTAL OR CONSEQUENTIAL DAMAGES (INCLUDING, WITHOUT LIMITATION, DAMAGE TO TAPES OR DISCS) RESULTING FROM THE USE OF THIS PRODUCTS, OR ARISING OUT OF ANY BREACH OF THE WARRANTY. ALL EXPRESS AND IMPLIED WARRANTIES, INCLUDING THE WARRANTIES OF MERCHANTABILITY AND FITNESS FOR PARTICULAR PURPOSE, ARE LIMITED TO THE APPLICABLE WARRANTY PERIOD SET FORTH ABOVE.

Some states do not allow the exclusion or limitation of incidental or consequential damages, or limitations on how long an implied warranty lasts, so the above exclusions or limitations may not apply to you.

This warranty gives you specific legal rights and you may also have other rights which vary from state to state.

For Product Information, Operating Assistance, Literature Request, Dealer Locations, and all Customer Service inquiries please contact:
1-800-211-PANA(7262), Monday - Friday 9 am - 9 pm, Saturday - Sunday 9 am - 7 pm, EST.

Web Site: <http://www.panasonic.com>
You can purchase parts, accessories or locate your nearest servicer by visiting our Web Site.

Accessory Purchases:

1-800-332-5368 (Customer Orders Only)
Panasonic Services Company 20421 84th Avenue South, Kent, WA 98032
(6 am to 5 pm Monday - Friday; 6 am to 10:30 am Saturday, PST)
(Visa, MasterCard, Discover Card, American Express, Check)

Listening to the Radio

You can tune directly to the station in **Free Mode** by finding the station's frequency, or you can store the station in **Memory Mode** to make tuning simpler. You can choose these modes with [TUNING MODE].

Free Mode

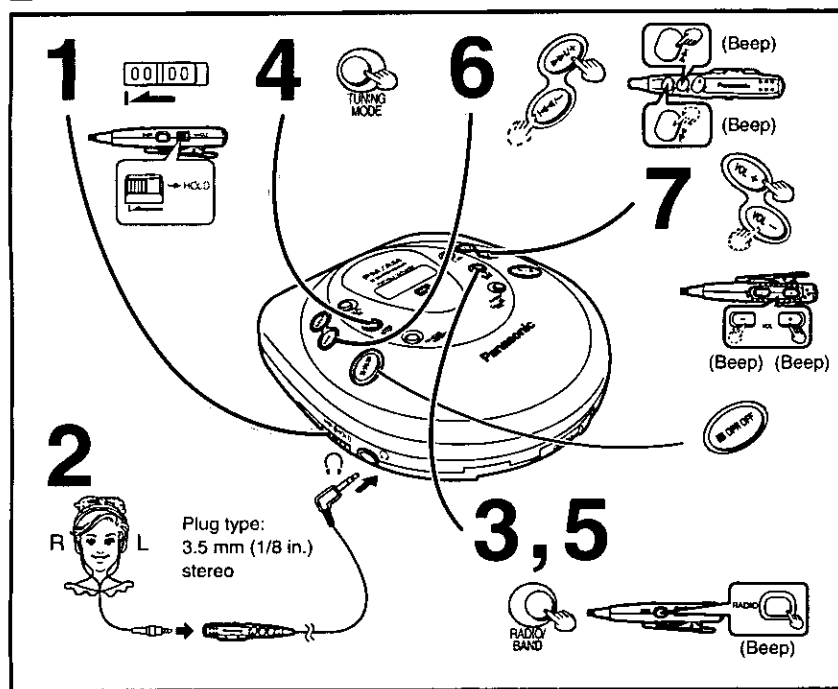

- 1 Release [HOLD].
 - 2 Connect the wired remote control and stereo headphones to [⊙]. (Plug in firmly.)
 - 3 Press [RADIO/BAND] (main unit) or [RADIO] (remote control) to turn on the radio.
 - 4 Press [TUNING MODE] (main unit) to set to Free Mode.
The display in Free Mode is as follows.
- S-XBS
FM 89.90 TUNED
- 5 Press [RADIO/BAND] (main unit) or [RADIO] (remote control) to change the band.
Each time the button is pressed;
FM ↔ AM
 - 6 Press [▶▶]/+, [◀◀]/- (main unit), or [▶▶] or [◀◀] (remote control) to select the frequency of the station.
▶▶/+ : increases frequency, ◀◀/- : decreases frequency
- For your reference:**
- Press for over 1.5 seconds to make the frequency change rapidly.
 - "TUNED" is displayed when a station is tuned.
- 7 Adjust the volume.

- **To turn off the radio**
Press [■, OPR OFF] (main unit) or press and hold [RADIO] (remote control).

Memory Mode

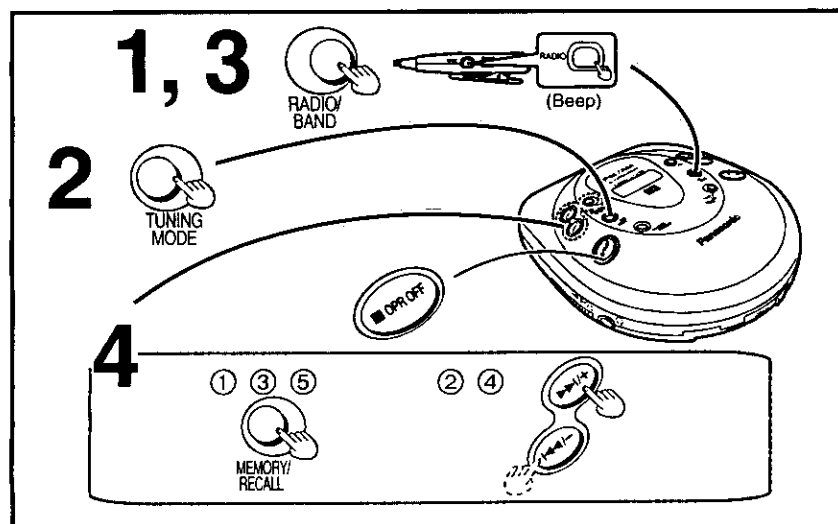

Putting stations into the channels

Frequencies of up to 30 stations can be stored; 20 FM and 10 AM.

Preparation:

- Release [HOLD].
- Connect the wired remote control and stereo headphones as they act as an FM antenna.

- 1 Press [RADIO/BAND] (main unit) or [RADIO] (remote control) to turn on the radio.
 - 2 Press [TUNING MODE] (main unit) to set to Memory Mode.
The display in Memory Mode is as follows.
- Memory number

S-XBS
MEMORY 2820 TUNED
AM
- 3 Press [RADIO/BAND] (main unit) or [RADIO] (remote control) to change the band.
Each time the button is pressed;
FM ↔ AM
 - 4 Put stations into the channels of your choice.
(Only on the main unit)
 - ① Press [MEMORY/RECALL].
The frequency number flashes.
 - ② Within 10 seconds
Press [▶▶]/+, [◀◀]/- to select the frequency to be memorized.
 - ③ Within 10 seconds
Press [MEMORY/RECALL].
The memory number flashes.
 - ④ Within 10 seconds
Press [▶▶]/+, [◀◀]/- to select the memory number to store the frequency.
FM station: up to 20/AM station: up to 10
• Press [▶▶]/+, [◀◀]/- for over 1.5 seconds to make the frequency or memory number change in succession.
 - ⑤ Within 10 seconds
Press [MEMORY/RECALL] to confirm the memory setting.

Important

After putting stations into channels, ensure the unit has a constant power supply. Leaving it without batteries or AC power for more than one minute can clear the memory.

■ Recalling preset stations

Preparation:

- Release [HOLD].
- Connect the wired remote control and stereo headphones to [⊙].
- Perform steps 1–3 of "Putting stations into the channels".

- 1 Press [▶▶]/+, [◀◀]/- (main unit), or [▶▶] or [◀◀] (remote control) to select the desired station.
Memory number and broadcast frequency changes.
- 2 Adjust the volume.

■ To erase unnecessary preset stations from the memory

(Only on the main unit)

Preparation:

Perform steps 1–3 of "Putting stations into the channels".

- 1 Press [▶▶]/+, [◀◀]/- to select the memory number to be erased.
- 2 ① Press [MEMORY/RECALL].
The frequency number flashes.
② Within 10 seconds
Press and hold [MEMORY/RECALL] until "-- --" flashes.
③ Within 10 seconds
Press [MEMORY/RECALL] to erase the memory number.
The memory number of the next preset station appears on the display.

■ To put a station into a channel you erased

Repeat the procedure described at left.

■ To turn off the radio

Press [■, OPR OFF] (main unit) or press and hold [RADIO] (remote control).

Listening to the Radio

The letters such as ❶ in the various illustrations refer to the descriptions in the "Location of Controls" section. (See page 2.)

To obtain good reception

AM

Try various directions to obtain optimum reception.

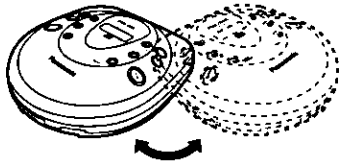

Note

The AM antenna is located in the lid of the unit so noise may increase if the unit is held. This is not malfunction.

FM

The headphone cord is also the FM antenna, so extend it instead of leaving it coiled.

How to receive an FM broadcast clearly

Press for more than 1.5 seconds during FM reception.

(Only on the main unit)

Each time the button is pressed;
"CITY" ← " " (normal)

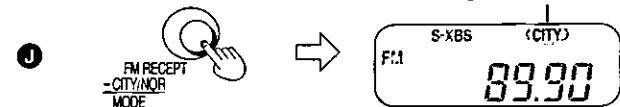

Leave off under normal conditions. Set to "CITY" if reception is poor or if there is interference from another station.

To select stereo or monaural FM

Press during FM reception.

(Only on the main unit)

Each time the button is pressed;
"MONO" ← " " (stereo)

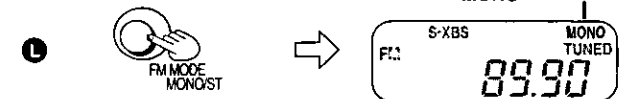

When there is noise during FM reception

Select "MONO".

Sound becomes monaural, but noise is reduced.

Concerning Compact Discs



Only compact discs bearing this mark can be used with this unit.

However, continued use of irregular shaped CDs can damage the unit.



How to remove a disc from its case

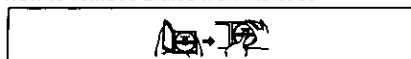

How to store the disc in its case

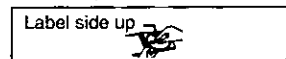

How to hold a disc

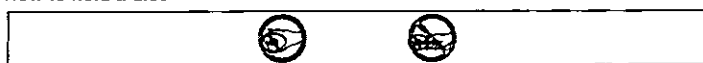

If the surface is dirty

Wipe it with a damp cloth and then wipe dry. Wipe from the center toward the outer circumference.



Handling precautions

- If you are taking the CD from a cold to a warm environment, moisture may form on the CD. Wipe this off with a soft, dry, lint-free cloth before using the CD.
- Do not write on the label side with a ball-point pen or other writing instrument.
- Do not use record cleaning sprays, benzine, thinner, static electricity prevention liquids or any other solvent.
- Do not attach labels or stickers to CDs. (Do not use CDs with exposed adhesive from tape or left over peeled off stickers.)

- Do not use scratch-proof protectors etc.

Storage precautions

Be sure to store CDs in their cases to protect them from dust, scratches, and warping.

Do not place or store CDs in the following places.

- Locations exposed to direct sunlight
- Humid or dusty locations
- Locations directly exposed to a heat vent or heating appliance
- In the glove compartment or on the rear deck of an automobile

When using overseas

(Only on the main unit)

Change the frequency step according to the area.

Preparation: Press [RADIO/BAND] to switch on the power.

1 Press for more than 5 seconds to display the step.



2 Within 10 seconds Press to select the step.

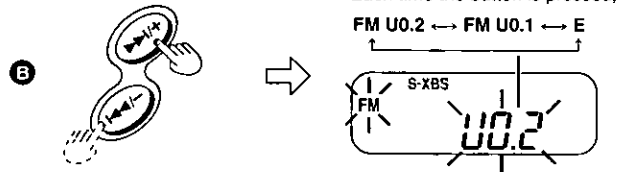

FM 00.2 (original setting) : FM 0.2 MHz, AM 10 kHz
FM 00.1 : FM 0.1 MHz, AM 10 kHz
E : FM 0.05 MHz, AM 9 kHz

3 Within 10 seconds Press and hold until the frequency is displayed to confirm the step.



To return to the previous frequency step

Repeat the above procedure.

Note

Converting the allocation erases the stations previously stored in memory.

Changing the sound quality

The operation is the same as when playing CDs. (See page 4.)

Product Service

- 1. Damage requiring service**—The unit should be serviced by qualified service personnel if:
 - (a) The AC power supply cord or AC adaptor has been damaged; or
 - (b) Objects or liquids have gotten into the unit; or
 - (c) The unit has been exposed to rain; or
 - (d) The unit does not operate normally or exhibits a marked change in performance; or
 - (e) The unit has been dropped or the cabinet damaged.
- 2. Servicing**—Do not attempt to service the unit beyond that described in these operating instructions. Refer all other servicing to authorized servicing personnel.
- 3. Replacement parts**—When parts need replacing ensure the servicer uses parts specified by the manufacturer or parts that have the same characteristics as the original parts. Unauthorized substitutes may result in fire, electric shock, or other hazards.
- 4. Safety check**—After repairs or service, ask the servicer to perform safety checks to confirm that the unit is in proper working condition.

Product information

For product information or assistance with product operation: Contact the Panasonic Customer Call Center at 1-800-211-7262, or e-mail consumerproducts@panasonic.com, or web site (<http://www.panasonic.com>). For assistance in the continental U.S.A. in obtaining repairs please ship the product to:

Panasonic Services Company - Customer Servicer
Suite B 4900 George McVay Drive
McAllen, TX 78503

In Puerto Rico contact the Panasonic Sales Company.
Tel. (787) 750-4300 Fax. (787) 768-2910

When shipping the unit carefully pack and send it prepaid, adequately insured and preferably in the original carton. Include a letter detailing the complaint and provide a day time phone number where you can be reached.

IF REPAIR IS NEEDED DURING THE WARRANTY PERIOD THE PURCHASER WILL BE REQUIRED TO FURNISH A SALES RECEIPT/PROOF OF PURCHASE INDICATING DATE OF PURCHASE, AMOUNT PAID AND PLACE OF PURCHASE. CUSTOMER WILL BE CHARGED FOR THE REPAIR OF ANY UNIT RECEIVED WITHOUT SUCH PROOF OF PURCHASE.

Also, the purchaser will be responsible for shipping the unit to the above address.

Specifications

CD SECTION

■ **Audio**
 No. of channels: 2 (left and right, stereo)
 Frequency response: 20 to 20,000 Hz
 (+0 dB to -8 dB)
 DA converter: 1 bit, MASH
 Headphone
 output level: RMS max. 6 mW+6 mW/
 16 Ω (adjustable)

■ **Pickup**
 Light source: Semiconductor laser
 Wavelength: 780 nm

RADIO SECTION

■ **Frequency**
 Radio frequency: **FM**; 87.90-107.90 MHz
 (0.2 MHz steps)
 87.50-108.00 MHz
 (0.1 MHz/0.05 MHz steps)
AM; 520-1710 kHz
 (10 kHz steps)
 522-1629 kHz
 (9 kHz steps)

GENERAL
 Power supply: DC 4.5 V with optional
 AC adaptor RP-AC46

Dimensions
 (W×H×D): 128×29.8×131.5 mm
 (5½"×1¾"×5¼")

Mass: 264 g (9.3 oz.)
 (with batteries)
 218 g (7.7 oz.)
 (without batteries)
 Operational temperature
 range: 0 °C-40 °C
 (32 °F-104 °F)

Play time:
 [Approximate operating time in hours (in
 hold mode with S-XBS canceled, at
 25 °C (77 °F) on a flat, stable surface)]

Batteries used	CD	RADIO (FM BAND)
2 alkaline batteries	25	75

- The play time may be less depending on the operating conditions.
- Play time will be considerably reduced when playing CD-RW.

Note:
 Specifications are subject to change without notice.
 Mass and dimensions are approximate.

Troubleshooting Guide

Before requesting service, make the below checks. If you are in doubt about some of the check points, or if the remedies indicated in the chart do not solve the problem, contact the **Panasonic Customer Call Center at 1-800-211-7262, or e-mail consumerproducts@panasonic.com, or web site (http://www.panasonic.com).**

Problem	Check this
Cannot close the lid.	Is the disc properly secured in place?
Cannot play discs.	<ul style="list-style-type: none"> • Is the unit in HOLD mode? • Is the disc properly secured in place? • Is the disc dirty or scratched? • Is there condensation on the lens? (Wait for about an hour and then try again.)
Tracks on disc do not play in order, starting with the first track.	<ul style="list-style-type: none"> • Is the random play mode on? • Did you stop play in the middle of the disc last time?
Cannot hear music—too noisy.	<ul style="list-style-type: none"> • Are the headphone and wired remote control plugs inserted all the way? • Are the plugs dirty? (Wipe away dirt on plug.) • Separate the unit from mobile phones.
TV picture is distorted. Radio reception is noisy.	Are you using the unit too near a TV or tuner? (Keep the unit away from the TV or tuner.)
No reception. The FM frequency range is different.	Has the frequency step been set for your area?

Cautions

Listening caution



Do not play your headphones or earphones at a high volume. Hearing experts advise against continuous extended play.

If you experience a ringing in your ears, reduce volume or discontinue use.

Do not use while operating a motorized vehicle. It may create a traffic hazard and is illegal in many areas.

You should use extreme caution or temporarily discontinue use in potentially hazardous situations.

Even if your headphones or earphones are the open-air type designed to let you hear outside sounds, don't turn up the volume so high that you can't hear what's around you.

Sound can be deceiving. Over time your hearing "comfort level" adapts to higher volumes of sound. So what sounds "normal" can actually be loud and harmful to your hearing.

Guard against this by setting your equipment at a safe level BEFORE your hearing adapts.

To establish a safe level:

- Start your volume control at a low setting.
- Slowly increase the sound until you can hear it comfortably and clearly, and without distortion.

Once you have established a comfortable sound level:

- Leave it there.

Care of dry cell batteries

To prevent battery damage, electrolyte leakage and short-circuiting, heed the following points.

- Do not peel off the covering on batteries and do not use if the covering has been peeled off.
- Align the poles ⊕ and ⊖ correctly when inserting the batteries.
- Do not mix different types or of batteries or old and new batteries.
- Remove the batteries if you do not intend to use the unit for a long time.
- Do not throw into fire, short-circuit, disassemble, or subject to excessive heat.
- Do not attempt to recharge dry cell batteries.
- Do not allow metal objects to touch the battery terminals as this may cause short-circuiting which is dangerous.
- When carrying batteries in a pocket or bag, ensure no metal objects such as necklaces are placed together with them. Contact with metal may cause short-circuiting which can cause a fire.

When driving a car

In the interest of traffic safety, do not operate the unit while driving.

Discontinue use if you experience discomfort with the headphones or any other parts that directly contact your skin. Continued use may cause rashes or other allergic reactions.

CAUTION!

THIS PRODUCT UTILIZES A LASER. USE OF CONTROLS OR ADJUSTMENTS OR PERFORMANCE OF PROCEDURES OTHER THAN THOSE SPECIFIED HEREIN MAY RESULT IN HAZARDOUS RADIATION EXPOSURE. DO NOT OPEN COVERS AND DO NOT REPAIR YOURSELF. REFER SERVICING TO QUALIFIED PERSONNEL.

CAUTION:

This equipment has been tested and found to comply with the limits for a Class B digital device, pursuant to Part 15 of the FCC Rules.

These limits are designed to provide reasonable protection against harmful interference in a residential installation. This equipment generates, uses and can radiate radio frequency energy and, if not installed and used in accordance with the instructions, may cause harmful interference to radio communications. However, there is no guarantee that interference will not occur in a particular installation. If this equipment does cause harmful interference to radio or television reception, which can be determined by turning the equipment off and on, the user is encouraged to try to correct the interference by one or more of the following measures:

- Reorient or relocate the receiving antenna.
- Increase the separation between the equipment and receiver.
- Connect the equipment into an outlet on a circuit different from that to which the receiver is connected.
- Consult the dealer or an experienced radio/TV technician for help.

Any unauthorized changes or modifications to this equipment would void the user's authority to operate this device.

This device complies with Part 15 of the FCC Rules. Operation is subject to the following two conditions: (1) This device may not cause harmful interference, and (2) this device must accept any interference received, including interference that may cause undesired operation.

User memo:

DATE OF PURCHASE _____
 DEALER NAME _____
 DEALER ADDRESS _____
 TELEPHONE NUMBER _____